

Control Data® 9448 Cartridge Module Drive

Designed for Original Equipment Manufacturers (OEM)

11/81
CD
CONTROL
DATA

DEC 3 1981

The Control Data Model 9448 Cartridge Module Drive (CMD) is a versatile, high-performance member of the CDC® module drive family. The CMD uses a removable, front-insertable, top-loading cartridge of 16 megabyte capacity, plus fixed disk capacities of 16, 48 or 80 megabytes.

The 9448 CMD uses the technologically advanced CDC 91204 cartridge media and has been specifically designed to be interface-compatible with 9.67 mHz controllers. The CMD offers OEM users ease of system design and versatility in system integration by providing the capability to combine the Control Data cartridge module, storage module and minimodule drives on a common controller.

Features

- Unique front-insertable, top-loaded cartridge
- SMD/MMD interface compatible
- Independent, manual write protection of cartridge and/or fixed media
- Microprocessor-based control logic
- Extended fault isolation and retention capability
- Hard (1-128) or soft (variable) sectoring capability
- Address mark generation and detection
- 9.67 mHz transfer rate
- NRZ to MFM data encoder with automatic write compensation and write current control
- Phase-locked oscillator/data separator
- Accurate track-following servo
- Dynamic brake
- Integral power supply
- Daisy-chain or star configuration



Options

- Heavy duty, bidirectional slides
- Acoustic quietized rack configuration
- Module family universal 1x or 2x cabinet

Functional Description

The Model 9448 basic unit uses a removable front load cartridge with 16 megabytes of capacity and contains 16 megabytes of fixed media capacity, front control panel, cartridge receiver, spindle, AC drive motor, AC blower system, braking system, read/write and servo heads, voice coil positioner and track-following servo, air filters and integral power supply. A logic chassis contains read/write, microprocessor, input/output servo and drive control electronics. Basic unit capacity may be expanded to 64 or 96 megabytes through increases of fixed module capacities.

A rotation speed of 3600 revolutions per minute enables the CMD to operate at a 9.67 mHz data rate. Head positioning is performed through the use of a field-proven closed-loop proportional servo system, with both acceleration and velocity feedback. The carriage is driven by a voice coil linear actuator, utilizing positioning information derived from a dedicated disk surface on the cartridge or one of the fixed disks. Field-proven read/write heads, patented by Control Data, provide a high degree of data integrity and servo accuracy. Dimensional integrity necessary for the recording system is provided by a precision spindle which is mounted in a rigid cast aluminum deck and ensures positive registration and seating of the cartridge to the spindle.

The 9448 CMD data recovery circuitry operates with either soft-sectoring formats containing address marks such as those found in variable sector formats, or hard-sectoring formats to a maximum of 128 sectors. The device is capable of operation in either star or daisy-chain configuration.

Interface Signals

Input Signals From Controller

Unit Select Tag—Leading edge samples the unit select bit lines for storage. The remaining true level enables the unit to say selected.

Unit Select 2⁰-2³—Carry binary logical address of the unit to be selected.

Cylinder Select Tag 1—Leading edge loads the absolute address from the 10-bit bus lines and the trailing edge initiates the seek.

Head Select Tag 2—Leading edge loads the head address from the 10-bit lines. Must precede Tag 1 when volume switching.

Control Select Tag 3—Used as gate enable which provides control information from the 10-bit bus lines and must be true for the entire control operation. Bus lines contain the following control information:

Bit 0 Write Gate—Enables the write drives.

Bit 1 Read Gate—Enables digital read data on the transmission lines.

Leading edge of Read Gate triggers the read chain to synchronize on all-zeros pattern.

NOTE: Data Strobe and Servo Offset signals are intended to be an aid in recovering marginal data.

Bit 2 Servo Offset plus—Actuator offset from the nominal On Cylinder position toward the spindle.

Bit 3 Servo Offset Minus—Actuator offset from the nominal On Cylinder position away from the spindle.

Bit 4 Fault Clear—Will clear the fault flip-flop if the fault condition no longer exists.

Controller

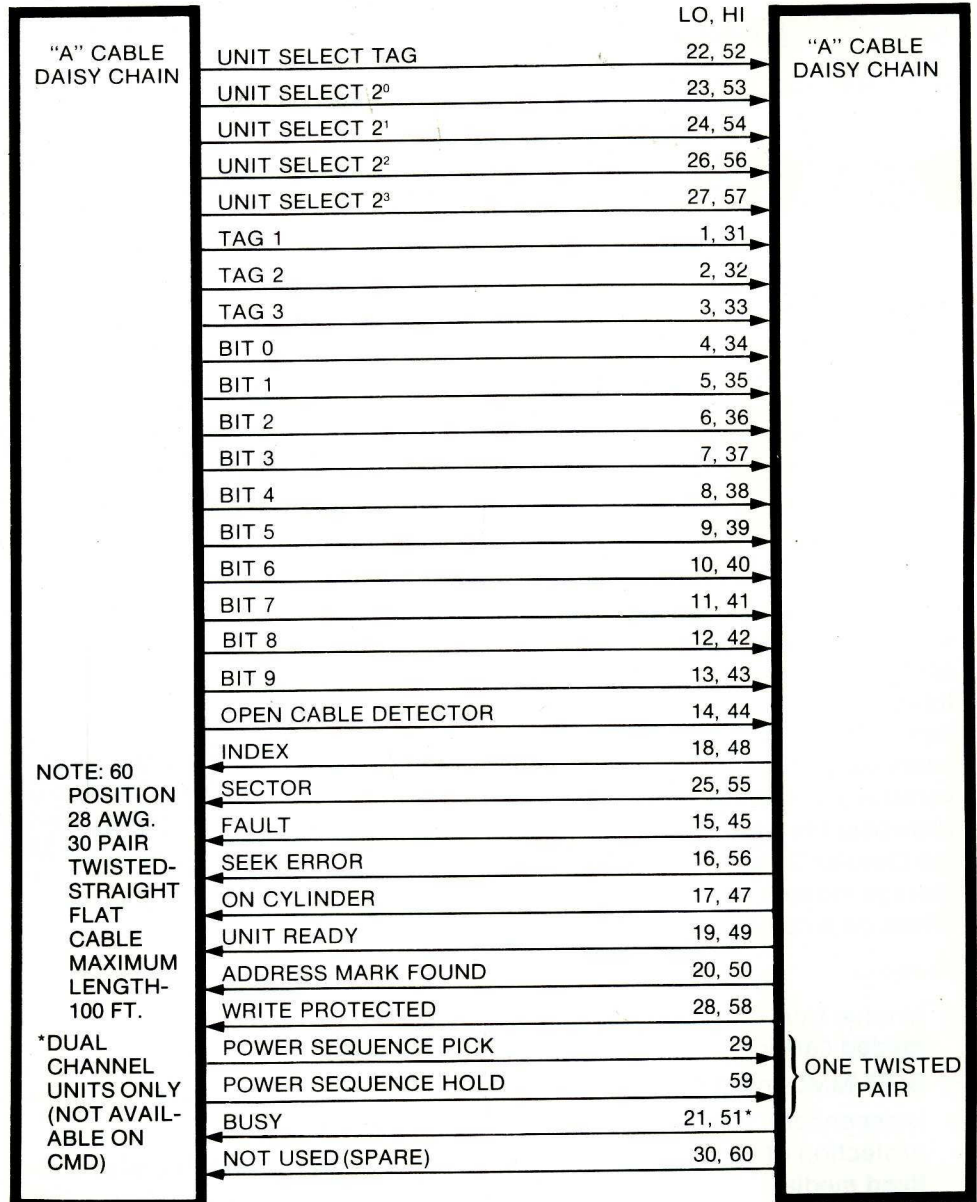

Bit 5 AM Enable—Address Mark Enable line, in conjunction with Write Gate or Read Gate, allows write or recovery of Address Marks. When AM Enable is true while Write Gate is true, the writer stops toggling and erases data, creating an Address Mark. Write Fault detection in the unit is inhibited by this signal. When AM Enable is true while Read Gate is true, an analog voltage comparator detects the absence of read signal. If the duration of the erased area is greater than 16 bits, an Address mark Found signal is issued.

Bit 6 RTZ—Pulse will cause the actuator to seek to Track 0, reset the Head Register, select cartridge volume, and clear the Seek Error flip-flop. This seek is significantly longer than a normal seek to Track 0, and should only be used for recalibration; not data acquisition.

Bit 7 Data Strobe Early—PLO Data Separator will strobe data at a time earlier than nominal.

Bit 8 Data Strobe Late—PLO Data Separator will strobe data at a time later than nominal.

Bit 9 Release (Dual Channel Only)—Reserved for SMD Compatibility. Dual channel not offered on CMD.

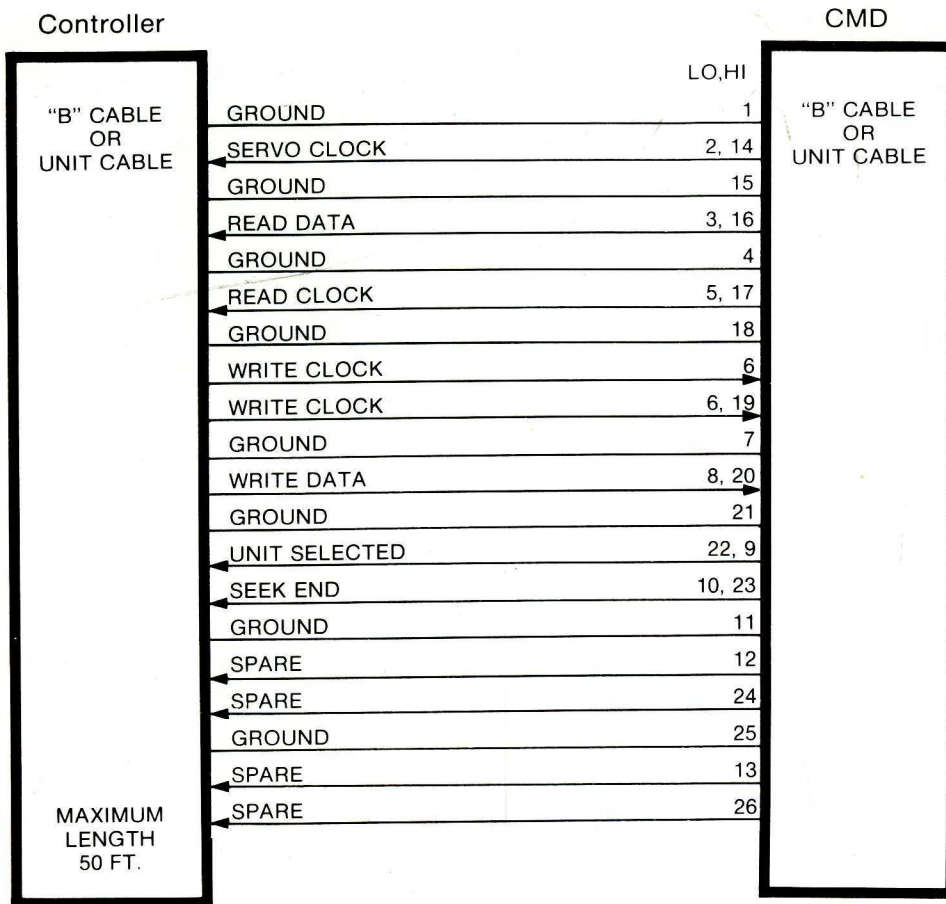

Power Sequencing

Power sequencing is an internal switch-selectable feature. When a ground is applied to the PS pick line, the CMD is allowed to power-up in the daisy-chain order. When this is up to speed, it will apply ground to the next unit to continue the sequence. This is used after a power interruption of the first power-up.

Open Cable Detector

This detector inhibits control functions taking place when not a true signal, as in the case of a disconnected "A" cable.

Output Signals to Controller

Unit Ready—Heads are loaded; no fault, and unit is up to speed.

On Cylinder—Indicates that heads are on track. The unit is ready to seek, read, or write.

Fault—One of the following faults exists: dc power fault, head select fault, write fault, write or read and not On Cylinder, or both read and

write at the same time. The fault inhibits writing. If the fault was transient, this status may be cleared by control select clear, operator panel clear, or fault clear in the logic chassis. Additional microprocessor fault summary status is available for maintenance diagnosis.

Seek Error—Unit was not able to complete a seek within 500 milliseconds, carriage has moved off position, or there was an attempted illegal seek. A return-to-zero (RTZ) will clear the Seek Error status and return heads to track zero.

Index—This pulse occurs once per revolution. Its leading edge defines the start of each track or sector zero. Index is gated off during volume switching.

Sector—Sector marks as well as the index mark are derived from the servo track. Number of sectors is switch selectable within the CMD.

Address Mark Found—Send during Address Mark Search, when there are at least 16 missing transitions detected on the disk. After receipt, AM Enable should be dropped and valid data will be present on the I/O.

Write Protected—Status which says the write circuitry is inhibited because: operator panel switch status, head alignment card installed, or during a fault condition.

Busy (dual channel only)—Reserved for SMD compatibility, dual channel not offered on CMD.

Seek End—On Cylinder or Seek Error. Indicates when a seek operation has ended.

Unit Selected—Occurs when the four unit select lines compare with the logic plug decode on the control panel, and the unit select tag is true. Allows physical identification of logical unit.

Read Clock—9.67 mHz clock derived from the MFM data recorded on the disk. The leading edge is used by the controller to sample the Read Data line.

Read Data—PLO-separated NRZ data, with 103 nanosecond cell time.

Servo Clock—Phase-locked 9.67 mHz clock, generated from the servo track dibits.

Write data—NRZ data with 103 nanosecond cell time to be converted within the drive to MFM and written on the disk.

Write Clock—9.67 mHz clock, which is Servo Clock turned around at controller and in phase such that the leading edge falls in the center of the 103 nanosecond cell of write data.

Interface Hardware

I/O Circuits

Industry Standard 75110 differential line drivers or equivalent.

Industry Standard 75108 differential line receivers or equivalent.

I/O Connectors

"A" Cable (60 pin) Amp., part number 88012-2.

"B" Cable (26 pin) Amp., part number 86905; 3M part number 3399-3000.

Cables

"A" Cable—30 twisted pair, flat cable, 100 (± 10) ohms characteristic impedance, 30.5 meters (100 feet) maximum length. Used in daisy-chain mode.

"B" Cable—26 conductor, flat cable with ground plane, 130 (± 15) ohms characteristic impedance 15.2 meters (50 feet) maximum length, 3M part number 3476/26. Used in radial mode as unit cable.

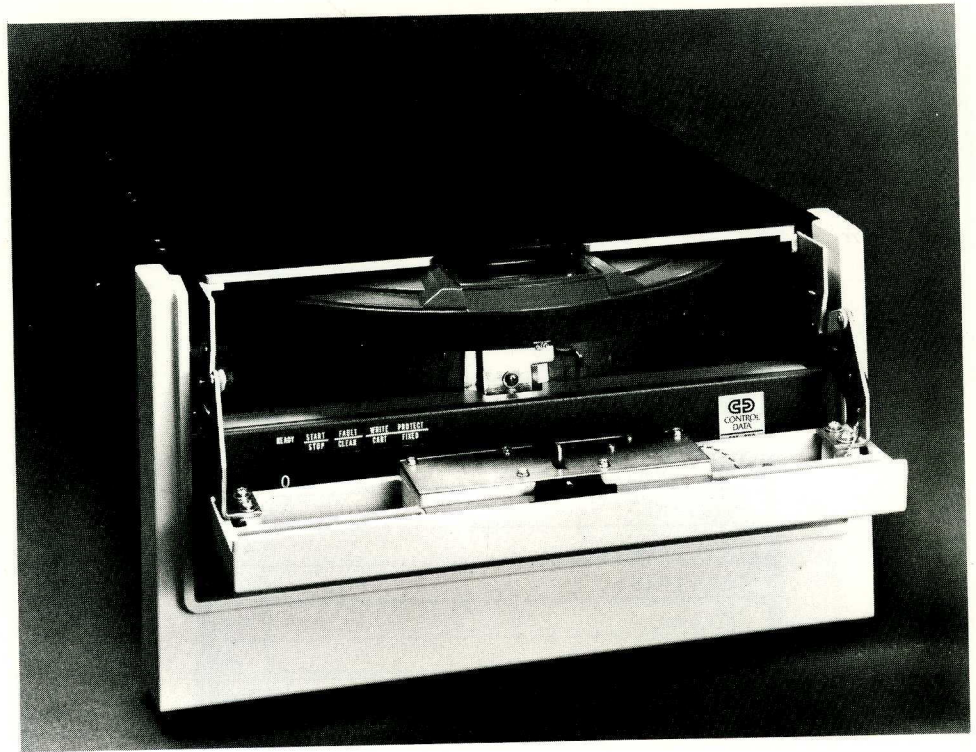

9448 Rack Mount

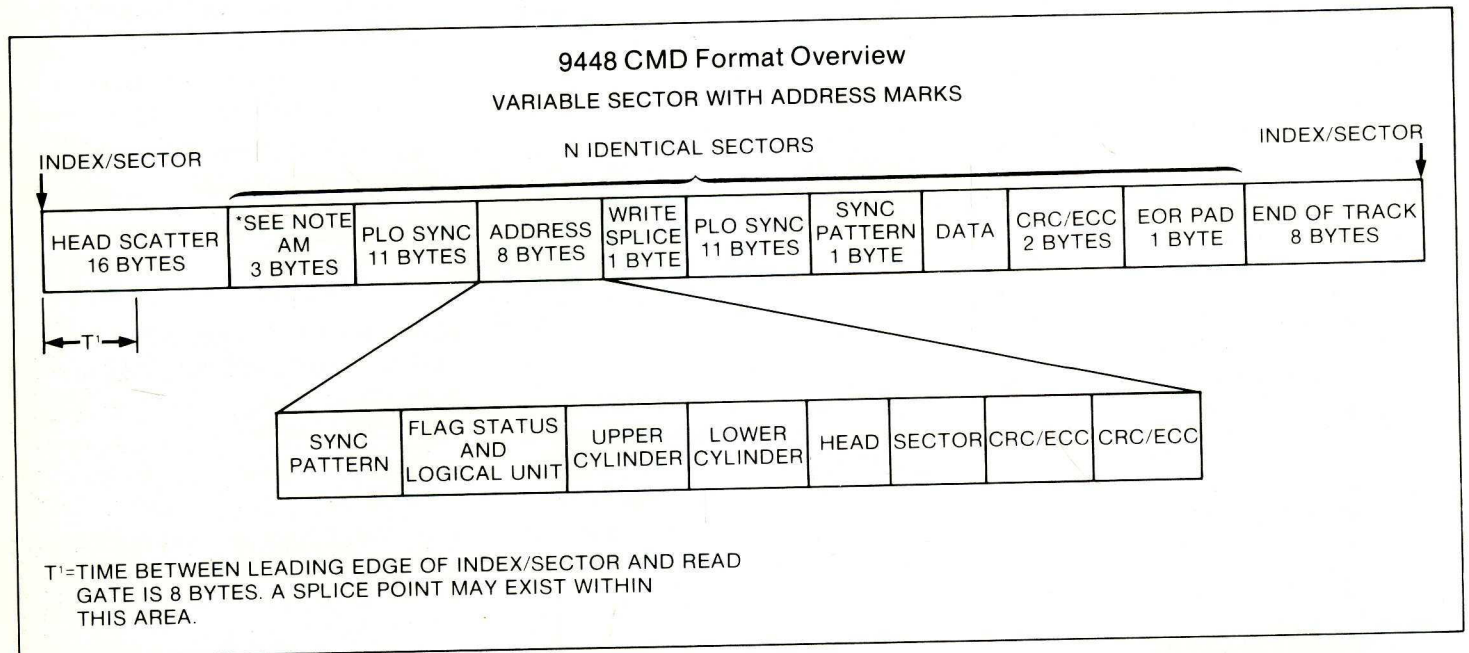

- **Head Scatter** —Mechanical tolerance of worst-case head adjustment. Heads reading early on information which was written by a late-positioned head. The opposite is also true, so the total head scatter is twice 8 bytes or 16 bytes.
- **Address Mark**—dc erased area on the track which is 3 to 3.5 bytes long
- **PLO Sync** —9 μ s of zeros
- **Sync Pattern** —At least one "1" bit to indicate to the controller that address or data information is next
- **EOR Pad** —End-of-Record Pad to ensure last data is not destroyed
- **End of Track** —Mechanical tolerance of 8 bytes for head scatter due to writing with an early head after an adjacent sector which was written by a late-positioned head

EXAMPLE NO. 1:

What is data field length using 64 sectors?

$$\text{Data Field} = \frac{\text{Total Bytes/Track} - \text{Mech. Tol. (Sync fields \& Address)}}{\text{Number of Sectors/Track}} = \left[\frac{\frac{\text{Bytes}}{20,160 \text{ Track}} - \frac{\text{Bytes}}{24 \text{ Track}}}{\frac{64 \text{ Sectors}}{\text{Track}}} \right] - 35 \text{ Sector} = 279 \text{ Sector}$$

$$\text{Data} = \frac{\text{Bytes}}{279 \text{ Sector}} - \frac{\text{Bytes}}{3 \text{ Sector}} = \frac{\text{Bytes}}{276 \text{ Sector}}$$

$$\% \text{ Efficiency} = \frac{276 \times 64}{20,160} \times 100 = 87\%$$

EXAMPLE NO. 2:

What is number of sectors using 256 data bytes?

$$N \text{ Sectors} = \frac{20,160 - 24}{256 + 3 + 35} = 68 \text{ Sectors}$$

$$\% \text{ Efficiency} = \frac{256 \times 68}{20,160} \times 100 = 86\%$$

NOTE:

*For fixed sector operation, Address Mark (AM) is not required; however, the Head Scatter and End-of-Track tolerances must be included in each sector. EXAMPLE NO. 1 WOULD THEN BE: What is data field length using 64 sectors?

$$\text{Data Field} = \frac{\text{Total Bytes/Track}}{\text{Number of Sectors/Track}} - (\text{Sync field, tolerance gaps, and address}) = \frac{20,160}{64} - 56 = 259 \frac{\text{Bytes}}{\text{Sector}}$$

$$\text{Data} = 259 - 3 = 256 \text{ Bytes/Sector}$$

$$\% \text{ Efficiency} = \frac{256 \times 64}{20,160} \times 100 = 81\%$$

CMD Design Features

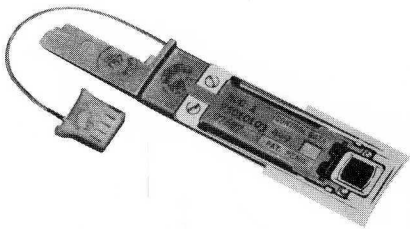

Advanced Read/Write Head Technology

- Improved dynamic response characteristics for superior read recovery margin at densities greater than 6000 bits per inch
- Patented fixed arm design concept improves response characteristics over other designs
- Field-proven photo-ceramic slider with glass bonded core utilized for improved flying reliability

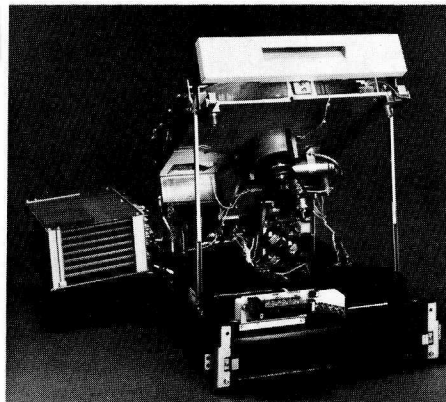

9448 Maintenance Accessibility

- Top access for major assemblies
- Hinged deck for under deck accessibility. Does not require bottom access
- Front access only on rack-mounted unit, allowing cabinet to be positioned against wall, saving floor space

Major Assemblies

- Rugged, ribbed deck casting for high strength-to-weight ratio
- High-performance air system filters particle sizes to 0.3 micron with 99.97 percent efficiency
- High-reliability, front insertable, top-load cartridge and receiver
- High reliability LSI micro-processor-based control logic

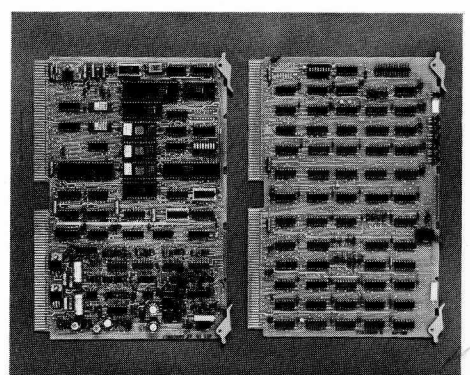
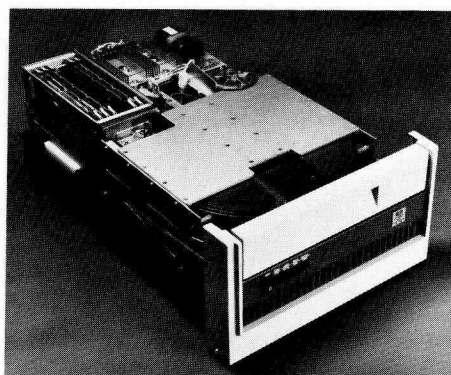
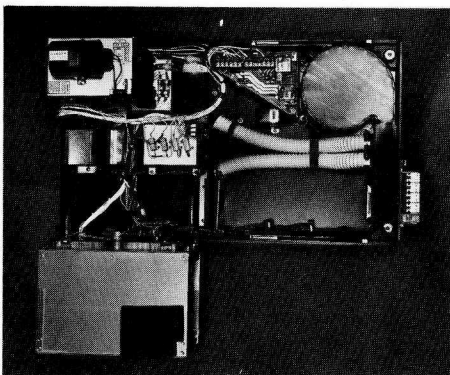
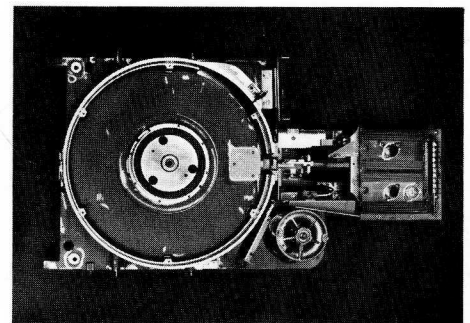

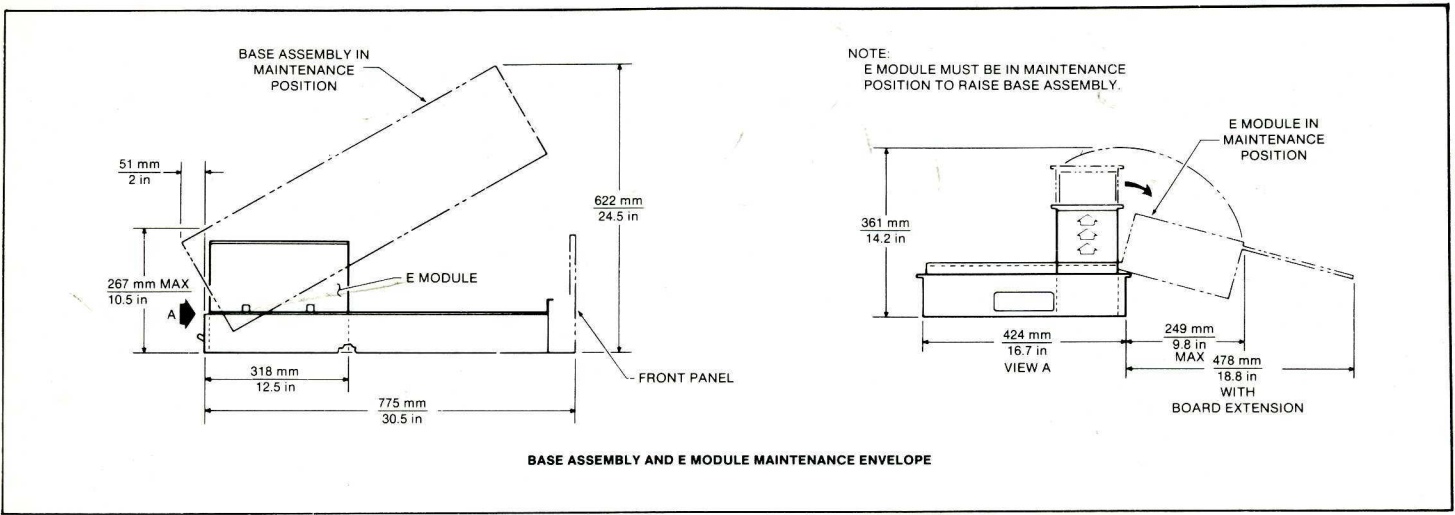

Custom Site Planning with the CMD

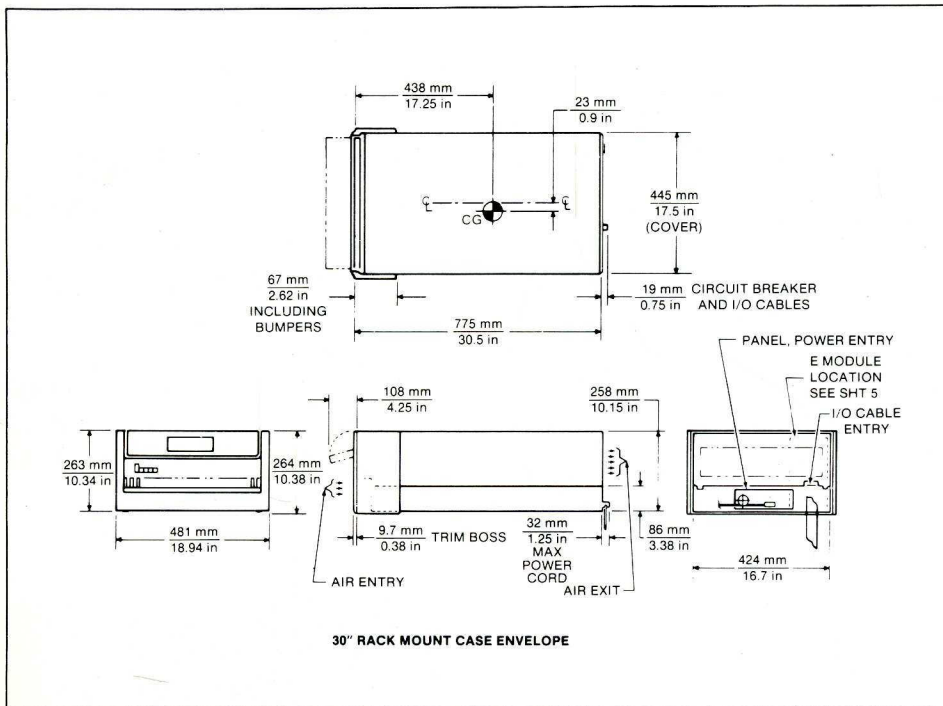

Physical Characteristics for 30" Rack Mount

Dimensions	Millimeters	Inches
Height	267	10.5
Width	483	19.
Depth	762	30.5

Weight 77 kg (170 lb)

Specifications

General

Capacity (20,160 bytes per track, unformatted)			
CMD Unit	9448-32	9448-64	9448-96
Bytes per Spindle (8-bit bytes)	32 Mb	64 Mb	96 Mb
Tracks per Surface	808	808	808
Spare Tracks per Surface	15	15	15
Track Density (tracks/in)	384	384	384
Track Spacing (millimeters)	0.0660	0.0660	0.0660
(inches)	0.0026	0.0026	0.0026
Data Surfaces	2	4	6
Servo Surfaces	2	2	2
CDC Disk Cartridge Model	91204		
CDC CE Cartridge Model	91204-51		
Recording Mode	MFM		
Bit Rate, nominal	9.67 mHz		
Diameter	355 mm (14 in)		
Coating	Magnetic oxide		
Performance (processing speed)			
Data Transfer Rate	1.2 Mb/s		
Spindle Speed	3600 r/min		
Bit Density	6038 bits/in, inner track 4038 bits/in, outer track		
Accessing Time			
Maximum Full Stroke	55 ms		
Average	30 ms		
Maximum One Track	6 ms		
Latency Time			
Maximum	17.4 ms		
Average	8.33 ms		
Recording Heads	9448-32	9448-64	9448-96
Read/Write Type	2	4	6
Servo Type	2	2	2
Read/Write Width (millimeters)	0.0508	0.0508	0.0508
(inches)	0.002	0.002	0.002
Type	Self-loading, single gap, no erase		
Data Error Rate Recoverable	Not more than one error in 10 ¹⁰ bits transferred		
Reliability and Service			
MTBF	4000 hours		
MTTR	Less than 1.5 hours		
Service Life	Five years or 20,000 operating hours		
Preventive Maintenance	Replace absolute filter at 9000 hours, maximum General inspection and cleaning at 3000 hours, maximum Less than 0.5 hours per 1000 hours operating		

Maintenance Features	No read/write adjustments One servo adjustment Fault (LED) indicators to isolate problems quickly Head alignment kit available AC power breaker Field-test unit available for head alignment, accessing and read/write operations
Operator Control Panel	Start/Stop switch with indicator Logic plug with Ready indicator Fault Clear switch with Fault Status indicator Write Protect switch (cartridge/fixed) with indicator

Power

Voltage	120,220
Frequency	60 Hz, 50 Hz
Phase	Single
Operating Current	8.2A, 4.0A

Environmental

Temperature	°C	°F
Operating	10 to 35	50 to 95
Transit	-40 to 70	-40 to 158
Storage	-10 to 50	-14 to 122

Humidity (providing there is no condensation)	
Operating	20% to 80% RH
Transit	5% to 95% RH
Storage	10% to 90% RH
Altitude	-300 to 1982m (-980 to 6,500 Ft)

Specifications subject to change without notice.

Control Data sales offices are located in principal cities throughout the world.

OEM Product Sales
CONTROL DATA CORPORATION
P.O. Box 0
Minneapolis, Minnesota 55440
Telephone: (612) 853-3617
TWX: 910-576-2978